

Original article

## 'KRAB' – new capabilities of the Polish Armed Forces

Norbert Swietochowski\*<sup>1</sup>, Dariusz Rewak<sup>2</sup>

<sup>1</sup> Institute of Command, General Tadeusz Kosciuszko Military University of Land Forces, [norbert.swietochowski@awl.edu.pl](mailto:norbert.swietochowski@awl.edu.pl)

<sup>2</sup> Operational Command of Branches of Armed Forces, Planning Directorate J5, Targeting Department, [darek.rewak@gmail.com](mailto:darek.rewak@gmail.com)

### INFORMATIONS

Article history:

Submitted: 12 December 2017

Accepted: 21 March 2018

Published: 30 June 2018

### ABSTRACT

*The implementation of 155 mm self-propelled howitzers 'Krab' into the Missile and Artillery Forces significantly improve their capabilities. Apart the howitzer, the battalion fire module 'Regina' consists of specialized command, reconnaissance, support and ammunition vehicles. The caliber of the howitzer adjusted to NATO standards allows for the application of the common ammunition, including precision-guided, with the range up to 40 km, which will enable striking the important targets in the enemy's rear combat zone. An artillery battalion (battery) equipped with the self-propelled howitzer 'Krab' owing to usage of the precision-guided munitions during the engagement will gain unprecedented capabilities with regards to impacting a target. Moreover, the battalion will be able to successfully fulfill tasks, which until recently could be executed by a general-military commander with the support of anti-tank reserves, tank subunits, special forces or tactical surface-to-surface missiles. The paper proposes organizational structures of the 'Krab' artillery battalion, variants of order of battle and methods of fire tasks execution.*

\* Corresponding author

### KEYWORDS

*artillery, fire support, Krab, Regina*



© 2018 by SJMULF. This is an open access article under the Creative Commons Attribution International License (CC BY). <http://creativecommons.org/licenses/by/4.0/>

## 1. Introduction

The implementation of the self-propelled howitzer (hbs) 'Krab' together with command, technical support vehicles and ammunition constitutes a breakthrough in the Polish artillery bringing the Polish Armed Forces into the company of the armed forces equipped with the modern artillery. Not only does it mean introduction into the service the advanced gun of the NATO-standard 155 mm caliber with the ammunition produced in Poland, but it is also increasing the efficiency and combat capabilities of the Polish artillery. 122 mm howitzers 2S1 'Goździk' and 152 mm gun-howitzers 'DANA' still in service in the Land Forces of Polish Armed Forces are older constructions which even with supercharged shells can fire at the range of 20 km, which constitutes

only half of the assumed maximum range of the new howitzer. Therefore, along with 'Krab' the artillery receives the new combat capabilities which enforce changes of the doctrines related to its usage.

The purpose of the current paper is to indicate chances and prospects opening to the modernized Polish artillery and present necessary organizational, structural and doctrinal changes ensuring the seamless implementation of the new howitzer into the armament of the Missile and Artillery Forces of the Polish Armed Forces.

## 2. General characteristics of 155 mm hbs 'KRAB'

Hbs 'Krab' is a merger of purchased from the British license on the production of the 155 mm howitzer As-90 'Braveheart'<sup>1</sup> turret system with a modern chassis produced by the South Korean Samsung Company. The technology of the turret systems backs to the beginning of the 1990s of the 20<sup>th</sup> century but the standard AS-90 gun barrel was replaced by a durable 52-caliber barrel which made 'Krab' one of the most cutting-edge artillery systems in the world (Fig. 1). Technical solutions applied in the British turret were polonized and improved while computerization of a fire control system was adjusted to requirements of a contemporary battlefield.

Hbs 'Krab' is a high mobility combat asset capable of the precise striking and destroying targets at significant firing ranges i.e. up to 40 km, and even 50 km (with the application of M982 EXCALIBUR<sup>2</sup> type ammunition) and 80 km (with the application of the VULCANO<sup>3</sup> type ammunition). The gun can fire all NATO<sup>4</sup> 155 mm artillery shells currently in service of NATO armies including cluster ammunition of M864 DPCIM<sup>5</sup>, SMArt<sup>6</sup> 155, FFV BONUS<sup>7</sup> and M898 SADARM<sup>8</sup> types owing to which it is able to de-

---

<sup>1</sup> Project by the British group BEA Systems – model AS-90. Footnote by the authors.

<sup>2</sup> M982 EXCALIBUR – projectile guided based on GPS system data. Projectile maximum range – 50 km, dispersion – up to 10 m. Currently the works on the new guidance and navigation unit (GNU) with semi-active laser (SAL) features are ongoing. Owing to SAL warhead the ammunition can be precisely guided even at moving targets, at targets which changed positions after the projectile has been shot and there is possibility to change the target in order to avoid e.g. civilian population losses. Footnote by the authors.

<sup>3</sup> In May 2014 at the Alkantpan training field in RSA the shooting with 155 mm precision-guided shells 'Vulcano' by the gun-howitzer PzH2000 was conducted. According to the manufacturer, in case of the precision-guided version of artillery shells 'Vulcano' the shooting range of PzH2000 can reach more than 80 km, without deterioration of fire accuracy. Footnote by the authors.

<sup>4</sup> JBMoU – joint ballistic requirements for the new 155 mm howitzers adopted by France, the UK and the USA, which determinates the length of barrel (52 calibers) and cartridge chamber capacity (23 dm<sup>3</sup>) enabling to reach the maximum initial velocity of the projectile (945 m/s) with the strongest charge. Footnote by the authors.

<sup>5</sup> M864 Dual Improved Conventional Munitions (DPCIM) – cluster shell containing sub-ammunition in form of 48 M42 grenades or 24 M46 grenades. M42 split into smaller fragments, deadly effective against personnel. Footnote by the authors.

<sup>6</sup> SMArt – Sensorfuzed Munitions for 155 mm Artillery (SMArt) – developed shell contains two sub-projectiles with the warheads which destroy a target by explosively formed penetrator (co-called opposed shaped charge effect). Targets acquisition is conducted with the use of infrared and millimeter wave sensors. Sub-projectiles parachute rotating and searching the terrain. Once a target is

stroy tanks, armored vehicles and also self-propelled guns. With the use of the latest technologies, shooting with high-explosive (HE<sup>9</sup>) ammunition, the gun is able to hit a target with the several meters precision at the maximum shooting ranges [see Storsved 2008]<sup>10</sup>. In this regard, 'Krab' is also predisposed to destroying other important objects of the enemy's order of battle infrastructure, including command posts, communication nodes or single missile launchers.



**Fig. 1.** 155 mm self-propelled howitzer 'Krab' on the South Korean K9 'Thunder' chassis by Samsung Techwin

Source: <http://www.money.pl/gospodarka/wiadomosci/artukul/eksport-polskiego-uzbrojenia-rzad-zajmie-sie,75,0,1908811.html>.

A contemporary artillery battalion (battery) equipped with hbs 'Krab' owing to usage of the precision-guided munitions during the engagement will gain unprecedented capabilities with regards to impacting a target. Moreover, the battalion will be able to

---

located and identified as an armored vehicle the warhead detonates and the target is struck by with the stream of iron of significant kinetic energy. Footnote by the authors.

<sup>7</sup> FFV BONUS – Swedish cluster shell of 155 mm caliber with the range 25 km produced by the FFV Bofors Ordnance Company carrying two self-guided anti-tank projectiles. It is the long-range projectile equipped with a gas producer. While shot, a time fuse splits the projectile at the altitude of 1000 m over a target. 6.5 kg sub-projectiles are equipped with folding fins which provide a stable spiral flight and an infrared sensor. The sensor is activated at the altitude of 150 m and as soon as a target is detected an explosively formed projectile with the velocity of 2000 m/s is shot towards the target [see Szymański 1993]. FFV BONUS

<sup>8</sup> M898 Sense and destroy Armor (SADARM) – the shell equipped with self-guided anti-tank warheads. The shell contains two sub-projectiles with 1.5 kg warhead each. After shooting, the projectile goes down on three small parachutes. Its infrared sensors and millimeter wave radar constantly search for hot elements of hostile assets e.g. engine compartments and 'radar mass' that is for example a tank turret with antennas. When the sensors recognize an enemy vehicle, an explosively former penetrator is shot down, at the upper point of the target which typically armored to the least extent at this point. Footnote by the authors.

<sup>9</sup> High Explosive (HE)

<sup>10</sup> Standard fuses for conventional ammunition are replaced by the special ones of Precision Guidance Kit (PGK) type. The construction of these fuses cause that the maximum projectile deviation from a target at the range of 30 km does not exceed 50 m.

successfully fulfill tasks, which until recently could be executed by a general-military commander with the support of anti-tank reserves, tank subunits, special forces or tactical surface-to-surface missiles.

Currently, destruction of targets with the precision-guided artillery shells is much more effective and an 'intelligent' artillery shell is significantly cheaper than a missile. What is more, compared to missile launchers, contemporary self-propelled guns, including 'Krab', are much more difficult to locate and destroy by an enemy's artillery. A subunit equipped with hbs 'Krab' due its capabilities and a full autonomy can disperse the battle formation without the necessity (as it is now) of creation easily predictable fire batteries and platoons formations over a very small area, exposed to covering of fire e.g. under *counterfire*.

The main effort by the HSW engineers was placed on the computerization of the all subsystems of 'Krab' which allowed for reduction of time required for achieving combat readiness by a gun and consequently by a platoon, a battery and a battalion. Such the solution provides the possibility of shooting a target from the march, immediately after a gun has been halted. It also enables for quick shifting of fire positions after or during execution of a fire task without losing the fire contact with the shelled target by a gun (fire echelon). Moreover, the solutions applied in which entire information, orders and commands are delivered within data transmission allow deviation from the traditional artillery commands and laborious shooting and fire control procedures whose preparation and delivery to executors absorb four-fifths of the time required for fulfilling a fire task.

Three interconnected computer systems were installed in 'Krab':

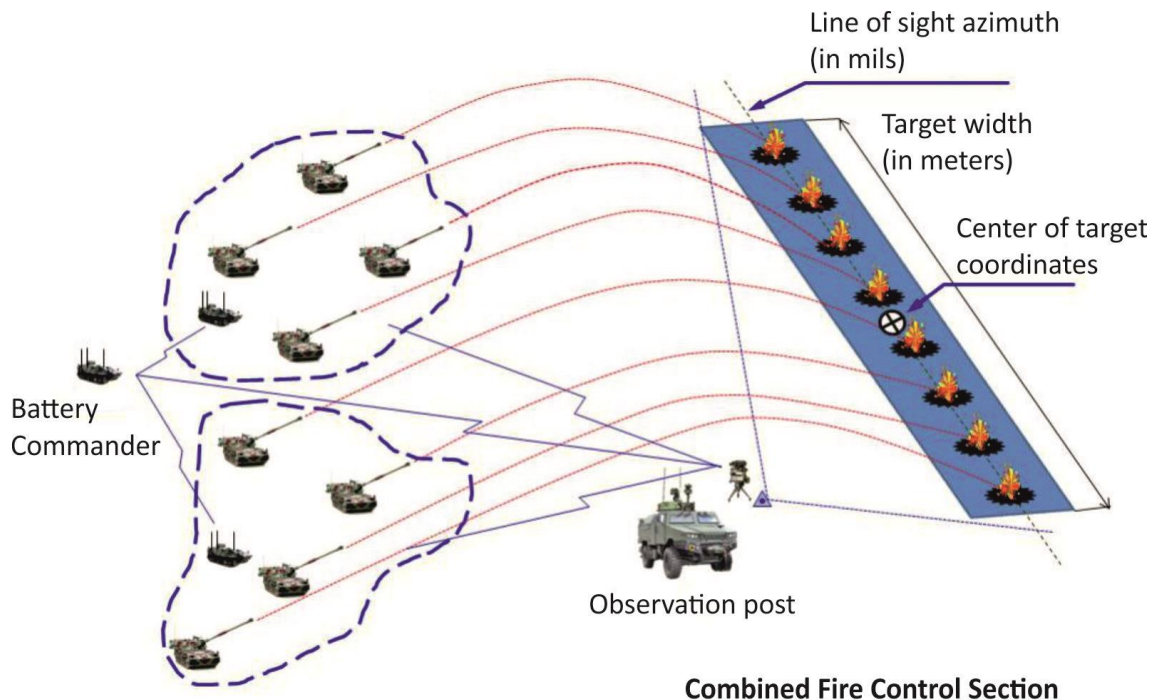
- **computer controlling the turret systems** which automates all processes related to a gun loading and aiming as well as shooting,
- **gunner's computer** which after receiving ballistic data controls in the automatic mode a turret systems computer (elevation and direction),
- **gun commander's ballistic computer** which provides a tactical picture on a digital map, performs ballistic computations and generates fire settings and controls a sequential shooting. Additionally, the commander's ballistic computer automatically cooperates with the external command and fire control systems.

An ultra-modern inertial land navigation unit based on a laser gyroscope and a road correction system through GPS is to be mentioned among the other electronic systems of the gun, closely linked to the fire control system. Such the solution enables a gun to be automatically fixed with the terrain and constantly monitored either during a combat engagement or on march. As soon as the gun halts, in real time after approximately 20 s (the time required for updating the GPS position), the gun's navigation system determines rectangular coordinates of the position of the gun as well as the topographical azimuth of the longitudinal axle<sup>11</sup> of the chassis. The longitudinal axis of the

---

<sup>11</sup> Hbs 'Krab' operates with NATO valid angular units of measurement in milliradians in which the round angle is described by 6400 milliradians. In the post-soviet system the artillery operated with thousandth which described the round angle by 6000 thousandth. Footnote by the authors.

individual gun simultaneously sets its primary direction of fire. These data are displayed on the ongoing basis on the gun's ballistic computer screen and automatically transferred to higher echelon's computers (platoon, battery and battalion). The self-fixing of the gun to the terrain in practically real time is of a significant importance for meeting an essential utility feature that is autonomy of a fire asset. The system provides connectivity with other howitzers and on the basis of the digitally collected parameters enables precise coordination of their activities and aiming all howitzers at a particular target within a given fire task regardless their positions (Fig. 2).



**Fig. 2.** Example of shooting 155 mm hbs 'Krab' battery at the wide target – variant  
*Source: Own study.*

A projectile initial velocity (muzzle) Doppler radar gauge, the same as in PzH 2000, constitutes another innovative solution, so far not existing in the Polish guns. Connection of this device with the ballistic computer provides ongoing correction of input data regarding the initial velocity of a projectile which is of the utmost importance for increasing accuracy of fire.

According to the authors of the article, the most significant advantages of hbs 'Krab' include:

- high mobility combined with automatic topographical fixing,
- full autonomy of the howitzer,
- rapid fire response time,
- increased accuracy of fire tasks execution,
- integrated communication, command and fire control systems (C4I),

- tactical picture displayed on a digital map at a gun commander position,
- automatic cooperation with external command and fire control systems of C4ISR<sup>12</sup> class, including artillery reconnaissance systems (SWO, RZRA, LIWIEC and BSL) and meteorological support (RSSA BAR),
- possibility of 'manual-emergency' execution of a fire task, even in case of total failure of all devices and systems responsible for fire control and target acquisition,
- possibility of automatic diagnosis of howitzer's systems and devices by a crew,
- operational simplicity of the howitzer systems, including openness of systems to development, configuration change and modernization,
- capability of interoperability with other allied communication systems (command and fire control),
- capabilities of conducting the operations under reduced visibility conditions, at any time of day or night, in any atmospheric conditions, under the impact of weapon of mass destruction (atomic, biological and chemical – ABC), in high humidity and dustiness conditions, ability to operate at altitudes up to 3000 m above sea level, under reduced atmospheric pressure to 600 hPa and in the range of temperatures from maximal +50°C to minimal -32°C.

The chassis of 'KALINA'<sup>13</sup> type which was originally used in the process of 'Krab' production unfortunately appeared to be unreliable. Thus, 'Krab' implementation program faced ceasing due to the fact that detected defects enabled conducting further operating-military research of the battalion 'Regina' module. Consequently, it was decided to replace chassis into operationally verified chassis of the South Korean K-9 'Thunder'<sup>14</sup> gun-howitzer.

In December 2014 a new stage of the development program of 155 mm self-propelled howitzer 'Krab'<sup>15</sup> began with signing the contract between HSW SA and Samsung Techwin (currently Hanwha Techwin). Due to this decision the carrier of the South Korean K9 'Thunder' was reconstructed in the way to comply with the HSW and the

---

<sup>12</sup> C4ISR (Command, Control, Communication, Computer, Intelligence, Surveillance and Reconnaissance).

<sup>13</sup> The chassis produced by ZM Bumar-Łabędy from Gliwice which was based on the modified motion system from PT-91 tank. Footnote by the authors.

<sup>14</sup> K9 Thunder – the South Korean self-propelled gun produced by the Samsung Techwin for the South Korean Armed Forces. K9 possesses entirely steel construction resistant to 14.5 mm ammunition shots, 152 mm munitions' fragments and blasts of personnel mines. 152 mm barrel of 52 calibers length with the maximum range of 40 km constitutes the main armament of the gun. The vehicle is equipped with the 1000 hp engine and the hydropneumatic suspension due to the mountainous Korean terrain. The vehicle is also fully ABC protected. The vehicle is adjusted to conduct shooting in MRSI mode – shoots three shells per five seconds at the various elevation angles to strike a target at the same time. Footnote by the authors.

<sup>15</sup> The agreement of 17 December 2014 guarantees HSW SA not only the access to the finalized and verified carrier for 'Krab' but also the rights for its license production, development of the construction as well as export both guns based on this carrier and other vehicle which will be built based on this construction. Source: <http://www.defence24.pl/271962,testy-poligonowe-kraba-ostatni-etap-przygotowan-do-produkcji-seryjnej-foto>.

Polish Ministry of National Defense requirements, for which the steelworks will finalize the realization of 'Regina' program.

It was not until August 2015 when the new chassis was integrated with the turret of 'Krab', and in October 2015 the factory handover-takeover tests were completed providing the ability to commence further operational-military research whose program was agreed and approved by the Ministry of National Defense. In April of the current year, two first modernized hbs 'Krab' came into service in the 11<sup>th</sup> Artillery Regiment in Węgorzewo.

Taking into account experiences gained during last armed conflicts, it can be stated that the artillery is and will continue to be a key striking asset, determining the success of contemporary combat operations. For that reason, it is to be assumed that hbs 'Krab' together with other artillery systems planned to be implemented in the Polish Armed Forces will become essential tools of fire support execution of engaged forces on a modern battlefield.

### **3. Proposal of organizational structure and equipment of 155 mm hbs 'KRAB' artillery battalion**

A self-propelled artillery battalion equipped with 155 mm hbs 'Krab' both owing to its equipment and organizational structure and unprecedented in the Polish Armed Forces tactical-combat capabilities should be able to execute fire support tasks covering entire depth of a combat formation of first echelon enemy's units (tactical groups). A general military commander will gain the possibility of free destruction of objects qualified for the battalion, battery and platoon or even a pair or a single gun fire striking. What is more, a subunit equipped with 'Krab' due to the possibility of usage precise-guided ammunition in an anti-tank battle is able to fight against, among others, enemy's armored groups at any place and time. The only limitation with this regard is the maximum shooting range of a particular type of ammunition.

According to the newest trends of the US Army, a platoon (three-gun platoon of 155 mm hbs M109A6 PALADIN) constitutes the smallest artillery subunit able to independently conduct operations. Under the current circumstances, it is also possible in the Polish context in 155 mm hbs 'Krab' battalion as 'Krab' can fulfil sequential shooting in the *MRSI* mode. In this mode the gun shoots up to three shells in different time intervals, at different angles of the barrel elevation in such way that all fired shells simultaneously hit a target. Reassuming, a four-gun hbs 'Krab' platoon is able to strike a target from the same position, at the same time with twelve concurrent shells (4 guns × 3 shells = 12 shells at a target<sup>16</sup>), then shift a fire position without losing contact with the target (i.e. while maneuvering, the guns are all the time 'fixed' to the target, thus, are able to open fire to the same target at any time, applying corrections to the first and subsequent salvos).

---

<sup>16</sup> Equivalent of salvo by 6-gun artillery battery. Foot note by the authors.

However, in order to provide the artillery appropriate freedom of operation it has to possess an efficient organizational structure and be properly equipped with, mainly in the scope of the operational support. During combat operations, a modern artillery battalion must be prepared to fulfil fire tasks at any place and time, within distinct configurations of a combat formation. It means that it is to be capable of executing fire tasks by three batteries at one target, but also by a platoon, a pair of guns or a single gun at several targets simultaneously. It will depend, among others, on enemy's activities, a type of terrain in shooting area, a task of the supported subunit (a unit, a tactical formation or operational formation) and the time (METT-T – Mission, Enemy, Terrain, Troops and Time). Therefore, the battalion and its subunits should form varied configurations of fire-strike groups depending on a received task.

According to the authors, organizational structures of a battalion equipped with 'Krab' should first of all provide full autonomy which will enable:

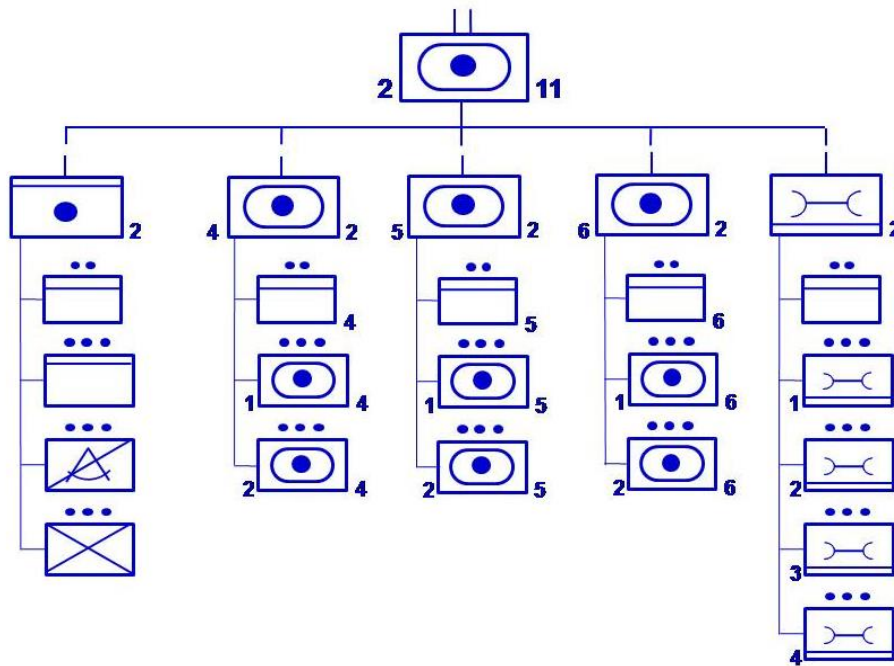
- logistical self-sustainment,
- command and fire control compatibility with other land forces command and fire control systems (e.g. C4ISR 'Jaśmin'),
- possibility of unrestrained gathering of data related to objects designated for striking from various available sources at the given area, including allied sources.

Two variants of 155 mm hbs 'Krab' battalion's organizational structures are presented below.

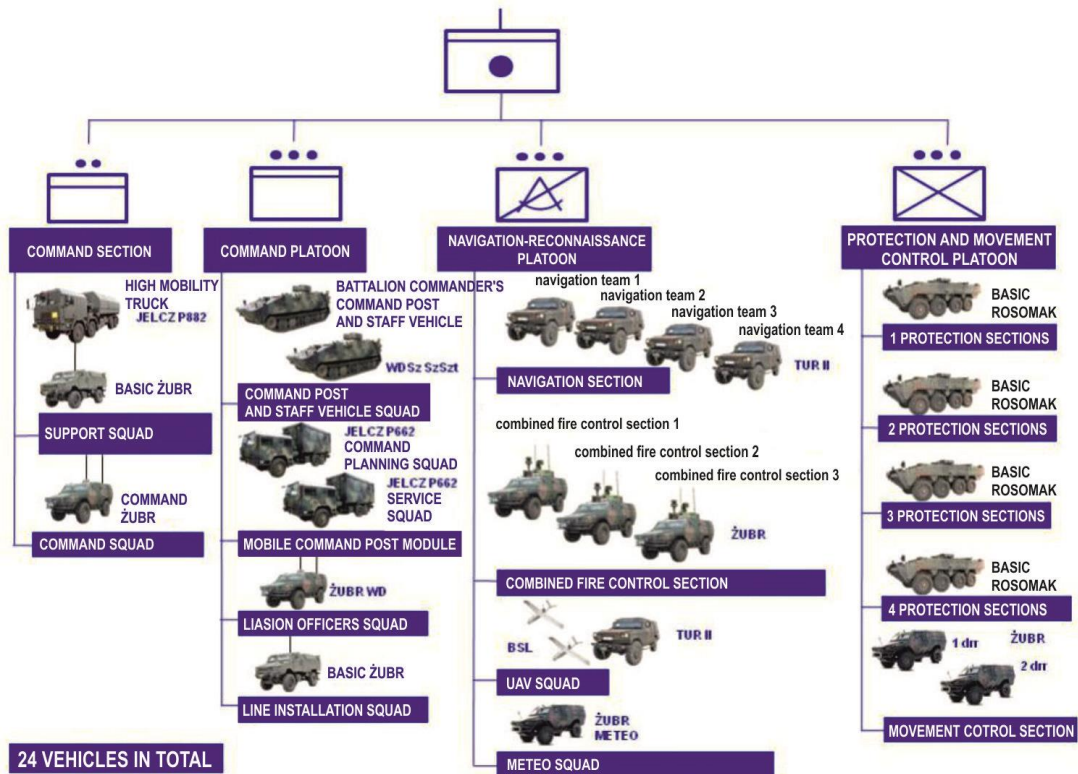
**VARIANT 1:**

In the first variant the authors propose a command battery and a logistic company which will enable the autonomy of combat batteries during combat operations. While transforming into crisis establishment (CE) structures during combat operations, individual platoons of the logistic company are subordinated to the command battery and three combat batteries. A commander of the logistic company together with the command squad reinforce an operation support group at the battalion command post, providing S-4 chief the support and communication with logistic elements attached to relevant batteries. Variant 1 is depicted in Figures 3-6.

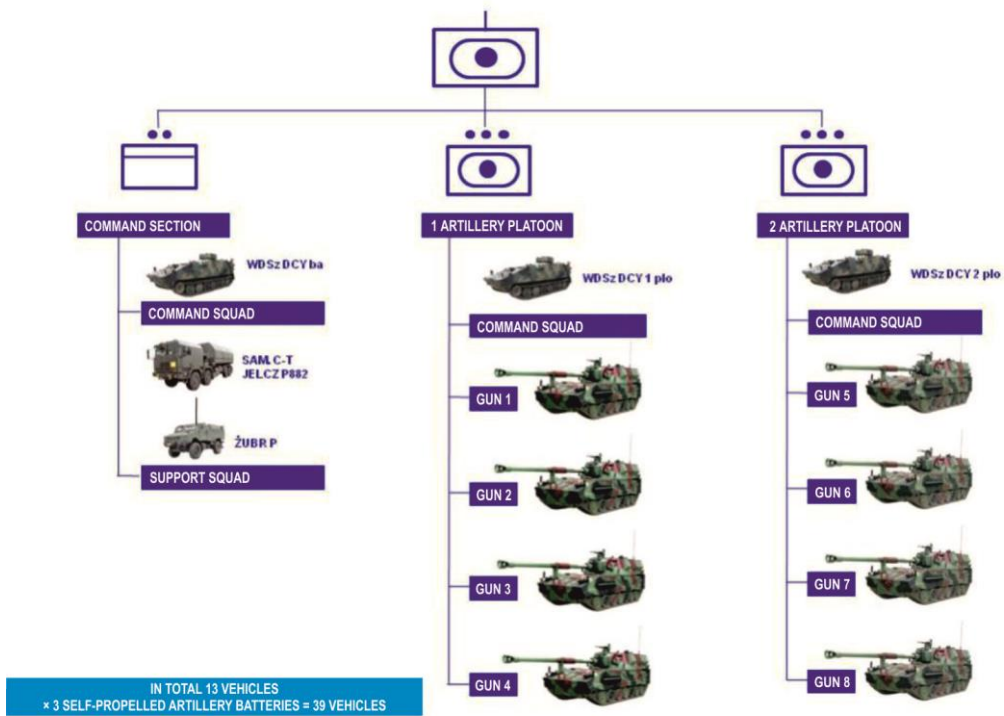




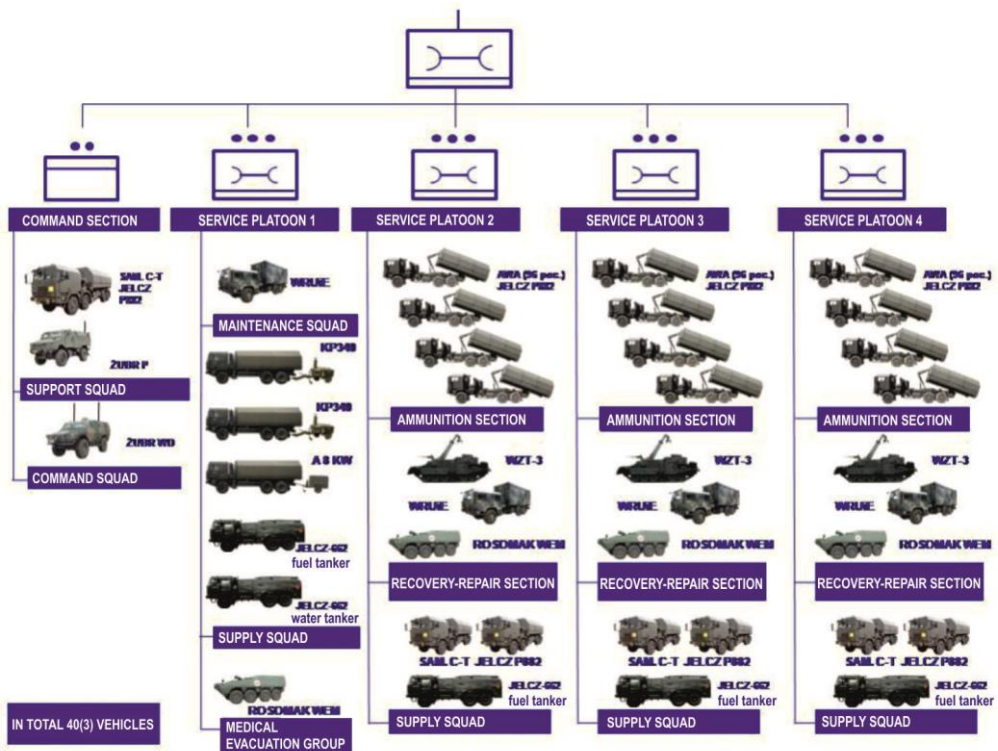
**Fig. 3** Organizational structure of 'Krab' artillery battalion with the extended (modular) logistic company – the variant  
*Source: Own study.*



**Fig. 4.** Organizational structure and equipment of a command battery – the variant  
*Source: Own study.*



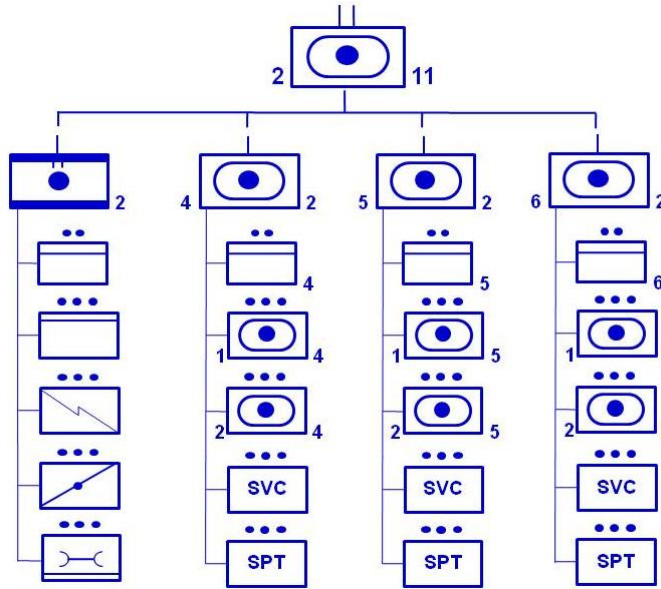
**Fig. 5.** Organizational structure of an artillery battery without logistic elements – the variant  
*Source: Own study.*



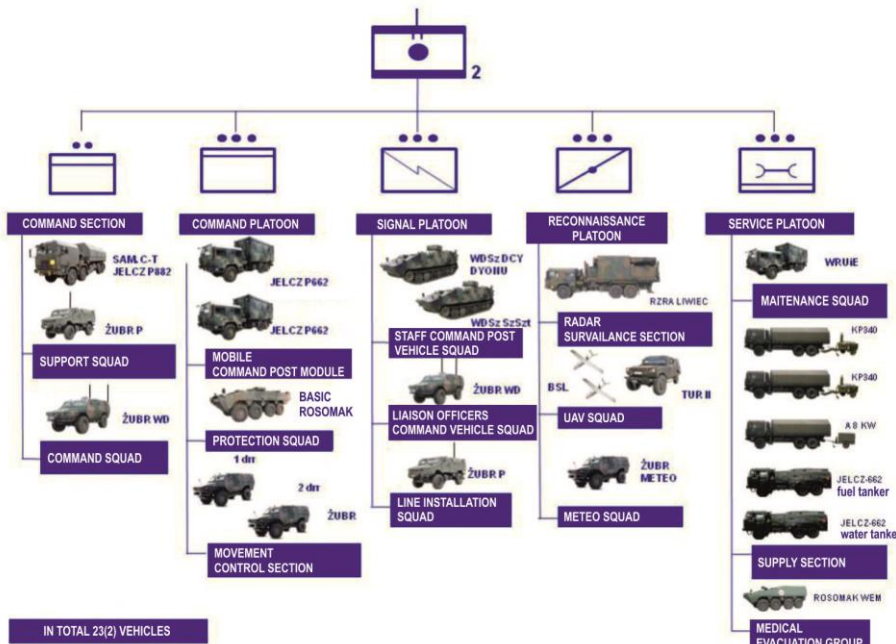
**Fig. 6.** Organizational structure of the logistic company with the modular platoons attached to the artillery battery for the period of a combat operation – the variant  
*Source: Own study.*

**VARINAT 2:**

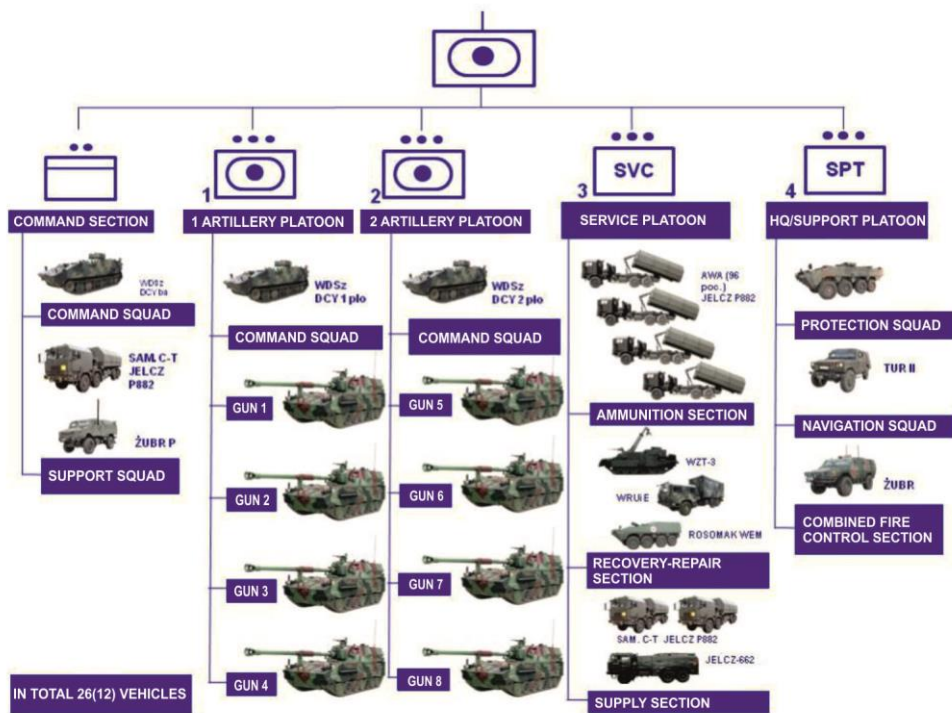
In the second variant, based on the German experiences, the authors propose the organizational structure of an artillery battalion without a logistic company with logistically autonomous combat batteries and extended command and support battery (see Figs 7-9).



**Fig. 7.** Organizational structure and equipment of ‘Krab’ artillery battalion with the logistically extended artillery batteries (without structural logistic company) – the variant  
 Source: Own study based on the Bundeswehr artillery organizational structures.



**Fig. 8.** Organizational structures and equipment of the command and support battery – the variant  
 Source: Own study.



**Fig. 9.** Organizational structure and equipment of 155 mm hbs 'Krab' artillery battery (independent in the scope of its operational support) – the variant  
*Source: Own study.*

Projecting the targeted architecture of 155 mm hbs 'Krab' battalion's organizational structures numerous factors were taken into consideration. The core identified factors include:

- a) time-consuming howitzer service-repair activities enforcing the need of having each combat battery equipped with at least one armament-electronic maintenance vehicle (WRUİE) and with minimum three automatic devices for de-preservation, cleaning and preservation of barrels<sup>17</sup>,
- b) gun dimensions and its mass which enforce equipping each combat battery with one heavy technical recovery vehicle WZT-3,
- c) high fuel consumption which enforces equipping each combat battery with one large-size fuel tank,
- d) necessity of conducting permanent control of a guns self-fixing and targeting as well as the necessity of creation in an area of howitzers operation (along the march route) a so-called local network of geological control points enforc-

<sup>17</sup> The device works in four modes according to the needs. De-preservation of a barrel from the solid oil, standard cleaning, intensive cleaning and cleaning of the cartridge chamber. The duration of work of a particular mode ranges from 4 to 15 min. With that borne in mind, the full scope cleaning of one gun will take approx. 60 min., and eight guns of a battery approx. 8 hours, hence there is a need of having a battery equipped with several such systems. Source: Website Centrum Szkolenia Wojsk Lądowych, Available at: <http://www.cswl.mil.pl/index.php/automatyczny-wycior/> [Accessed: 22 July 2013].

- es establishing in the battalion the structural geodetic and navigation subunit (in the command battery) which should be equipped with vehicles possessing identical or higher category inertial navigation system and GPS,
- e) fact that 155 mm hbs 'Krab' battery is able to execute tasks as independent fire module which will be able to conduct autonomous combat operations in designated artillery maneuver areas (AMA) enforces the necessity of establishing an independent medical evacuation group and protection squad at its level,
  - f) possibility of autonomous conducting combat operations by two howitzers as a so-called 'pair of guns' enforces the necessity of having attached to this pair an ammunition vehicles carrying approx. 90 rounds of ammunition which results in possessing at least four ammunition vehicles in 8-gun battery,
  - g) equipping the command battery with:
    - MMSD – Mobile Command Post Module,
    - UAV set – unmanned aerial vehicles,
    - RZRA – Artillery Mobile Locating Radar e.g. LIWIEC,
    - modern atmosphere sounding system,
    - modern HF, VHF and satellite communication systems,
  - h) necessity of incorporating into the structure of a 'Krab' battalion appropriately equipped guard unit up to the battery level as well as anti-aircraft defense subunits.

Creation of the optimal organizational structure of 155 mm hbs 'Krab' battalion ought to constitute one of the key aspirations in ongoing works in the Department of Missile and Artillery Forces of the General Command of Branches of Armed Forces related to modernization of the artillery. Presented in the article variants of the organizational structures and optional equipment of 155 mm hbs 'Krab' battalion are to be only considered as a proposition which was developed based on analysis conducted by the authors on the basic armament and equipment of the battalion fire module 'REGINA' and functioning in various armed forces of NATO states organizational structures of the artillery units. The assumptions of aforementioned variants of the organizational structures, their equipment and composition can provide a useful basis to undertake further deliberations on developing an optimal organizational structure of the Polish self-propelled artillery battalion of the 21<sup>st</sup> century, armed with unified equipment and, most importantly domestically produced.

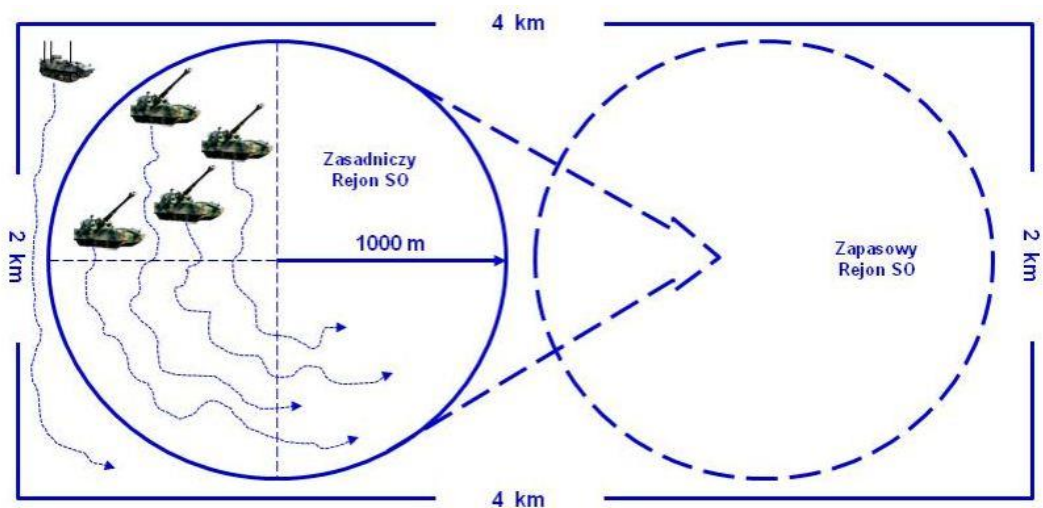
#### **4. Order of battle of 155 mm hbs 'KRAB' battery (battalion)**

An evolutionary character of a contemporary battle field together with its unpredictability requires the operational flexibility from the artillery including decentralization of the own combat formation with simultaneous possibility of fire centralization at any place and time.

Fire assets, subordinated to the Missile and Artillery Forces of the Polish Armed Forces, are deployed to fire positions pursuant to easily predictable and detectable by an enemy instructional regulation on positioning into a battle formation. Currently in force

in the Polish Armed Forces model of an artillery battery order of battle in so-called line (battery front) causes that the battery can be easily stuck by an enemy's artillery battalion as one 300 × 200 m target. In this regard, one fire storm by e.g. 152 mm ahs 2S19 MSTC-C battalion with the appropriate consumption of ammunition can incapacitate 152 mm ahs 'DANA' battery that is achieve the fire effects causing approximately 30% irreversible losses in personnel and equipment. Practically, it would mean that as a result of a single fire task executed by an enemy's artillery battalion three guns in 152 mm ahs 'DANA' batter will be destroyed ( $8 \times 0.3 = 2.4$ ).

Developing the concept of using 155 mm hbs 'Krab' in combat, the authors followed the verified methods of the artillery deployment in leading armies in the world. For example, in the US Army the self-propelled artillery battery M109A6 Paladin receives an operational area (fire positions – FP) of 3000 × 3000 m size. This area is divided into two equal parts, each for one platoon. 3-gun platoon as the basic fire module operating in the area of 1500 × 3000 m size receives four and even more fire positions. These fire positions are approximately 500 m up to 730 m apart. The guns in FP area deployed at distance from 100 to 150 m apart. Platoon formations can take different forms e.g. a diamond, a star or irregular geometric figures. The position of the gun is only of importance when it comes to execution of fire task over an edge of the covert (at the minimal firing range). The guns are independent with regard to fixing their positions and targeting. It is caused by the fact that the fire control system counts settings individually for each gun. Dispersion of the guns while executing a fire task is of the utmost importance for decreasing the level of losses thus affecting increase of fire echelon sustainability during combat operations. Figure 10 presents the variant of 4-gun 'Krab' platoon operation based on the American models.

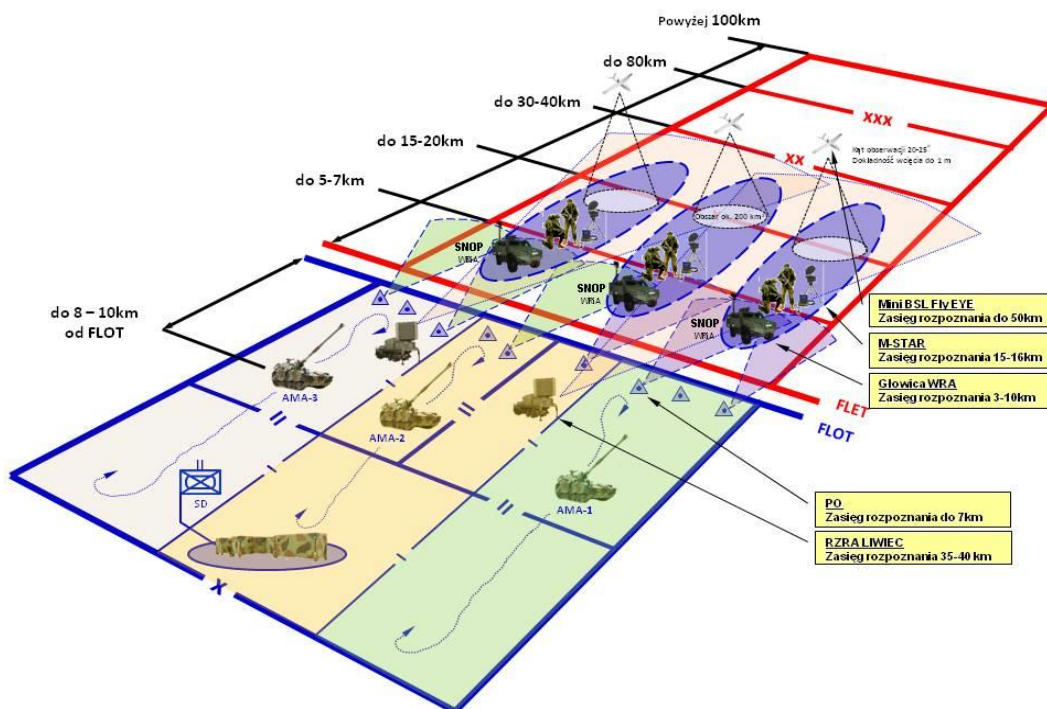


**Fig. 10.** 155 mm hbs 'Krab' platoon operation in the primary FP area – the variant

*Source: own study based on [FM 3-09.70. 2000].*

The hbs 'Krab' battalion has to be capable of decentralizing the order of battle over a more than a little area. Its size will depend on capabilities of digital radio assets regarding unrestrained and undistorted data transmission between all elements of a battle

formation, a higher HQ and reconnaissance elements supporting the battalion<sup>18</sup>. Such capabilities of the hbs 'Krab' battalion allow deviation from current, template artillery formations in FP areas and the methods of the artillery dislocation in the own battle formation. According to the authors adopting these solutions in the future will simplify complicated procedures of planning artillery maneuver in combat. Moreover, it should facilitate solving a problem of commanders at all levels: how to redeploy an artillery battalion (a support company) during fire engagement to the further fire position area maintaining fire support continuity of fighting troops. For this reason, the term **'fire positions area'** currently in force in doctrinal documentation of the Missile and Artillery Forces is replaced by the term **'artillery maneuver area'** (AMA [AAP-6... 2013, p. 60]<sup>19</sup>). The size of AMA should be dependent on the size of supported general military subunit (unit) area of operation. It seems to be the most reasonable to plan and mark the AMA areas in advance on a map, in which the artillery units would have the priority in deploying its elements of the order of battle, simultaneously respecting positions and tasks of elements of the battle formation of general purpose subunits.



**Fig. 11.** Maneuver areas of an artillery battery of 155 mm hbs 'Krab' battalion in defense – the variant  
Source: Own study.

<sup>18</sup> As proved by the experience gained during research conducted ZWRiA DG RSZ, it is considered to equip 'Krab' battalion with broadband radio stations in order to increase the capability of long-range data transmission, which in turn can have the negative impact on concealment of combat formation of fire echelon. Footnote by the authors.

<sup>19</sup> Artillery Maneuver Area (AMA) – an area in which deployment of artillery is authorized, but it is not restricted only for its operation.

The provided proposals regarding the future model the artillery operation determine a necessity of correlation activities of artillery and general military subunits in a shared area. As a result, a constant combat situational awareness in an area of operation and mutual information flow regarding current positions of units in an occupied area will be required. It is possible to achieve under the condition when general military battalions and companies are equipped with automated command and fire control system and higher HQs (artillery regiments, general military units and tactical formations) with digital systems enabling constant tracking of a battle situation, coordinating positions of own subunits and real-time tasking (close to real time).

### **5. Execution of fire tasks by 155 mm hbs 'KRAB' battery (battalion)**

The artillery can be equipped with automated command and fire control systems e.g. the German ADLER or the American AFATDS<sup>20</sup>. In the REGINA module the newest version of the Automated Fire Control System TOPAZ (ZZKO TOPAZ) designated for 155 mm hbs 'Krab' is used.

On battlefield artillery units receive information about an enemy in real, or close to real, time and the period required to obtain the information on an enemy and pass it for the purpose of fire strike normally does not exceed one minute. Modern armies apply for the needs of the artillery fire satellite reconnaissance, UAV, data obtained from deep reconnaissance groups and radio location stations (AN/TPQ-36, AN/TPQ-37<sup>21</sup>, AN/TPQ-53<sup>22</sup>, ARTHUR<sup>23</sup>, COBRA<sup>24</sup> and 1Ł220 ZOOPARK-2 [see Szulc 2011, p. 32]<sup>25</sup>) which are capable of forwarding data to a fire direction center (FDC) within the period of 30-40 s from a target acquisition. In turn, the mean time of a fire task execution by modern fire assets can be as follows:

- for self-propelled howitzer M109A2/A3 – 30-40 s,
- for self-propelled howitzer M109A6 – 30 s,
- for MLRS system – 60 s, (for ATACMS missiles – 20 s [Jarecki 1998, p. 52]).

Within *counterfire* the aggregate time of target acquisition, data flow, execution of a fire task and a shell flight time in various armies range from 3 to 5 min. The American

---

<sup>20</sup> Advanced Field Artillery Tactical Data System (AFADTS) – currently the most advanced artillery command and fire control system in the world. Footnote by the authors.

<sup>21</sup> AN/TPQ – the type of stations is equipped with an impulse Doppler radar which after recognition of an enemy's shooting artillery with the use of a digital line transfers target coordinates to a fire coordination center where decision on counterfire is made. Footnote by the authors.

<sup>22</sup> The station which since 2011 was to replace long-serving 36 and 37 stations.

<sup>23</sup> ARTHUR (Artillery Hunting Radar).

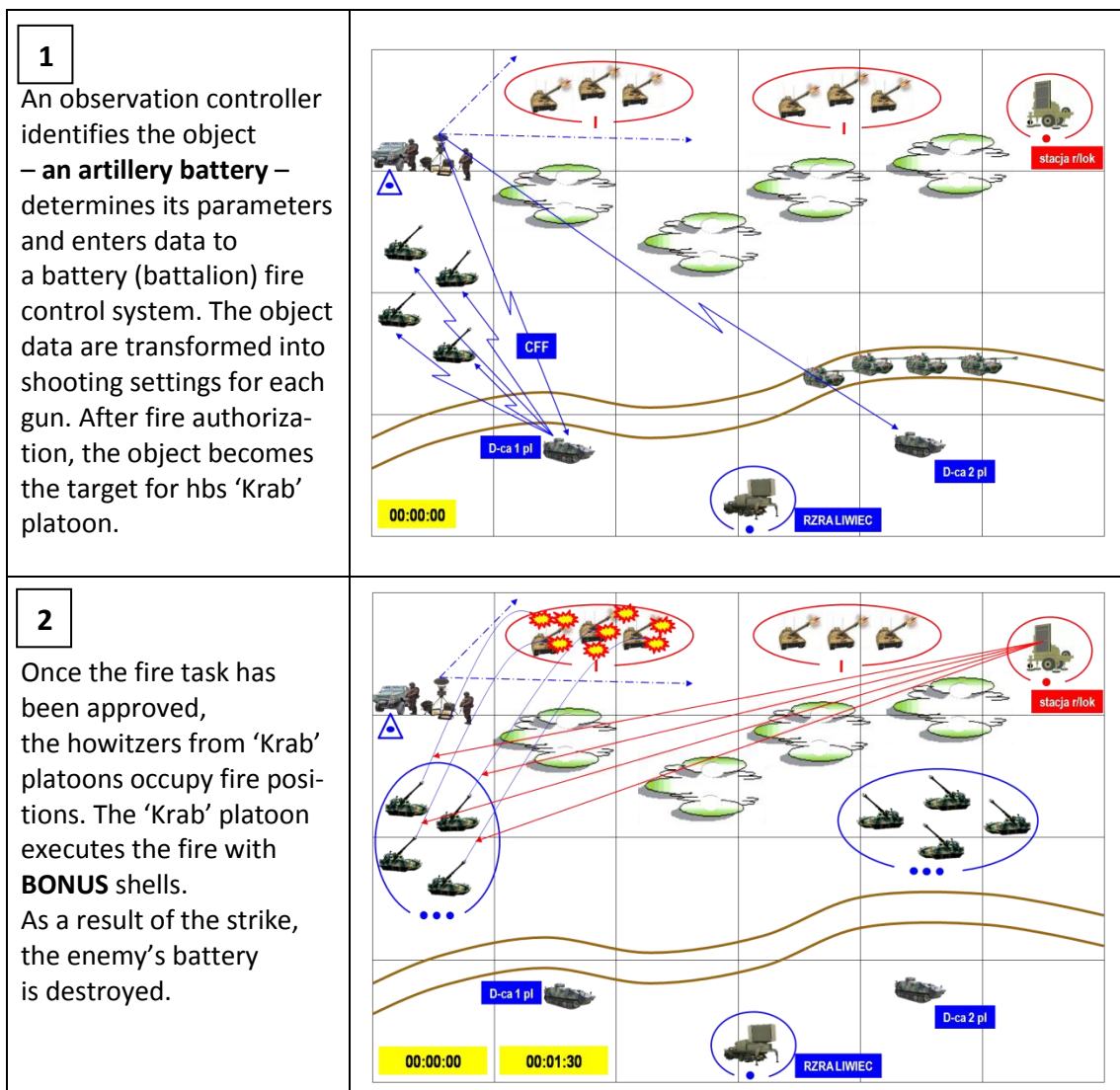
<sup>24</sup> COBRA (The Counter Battery Radar).

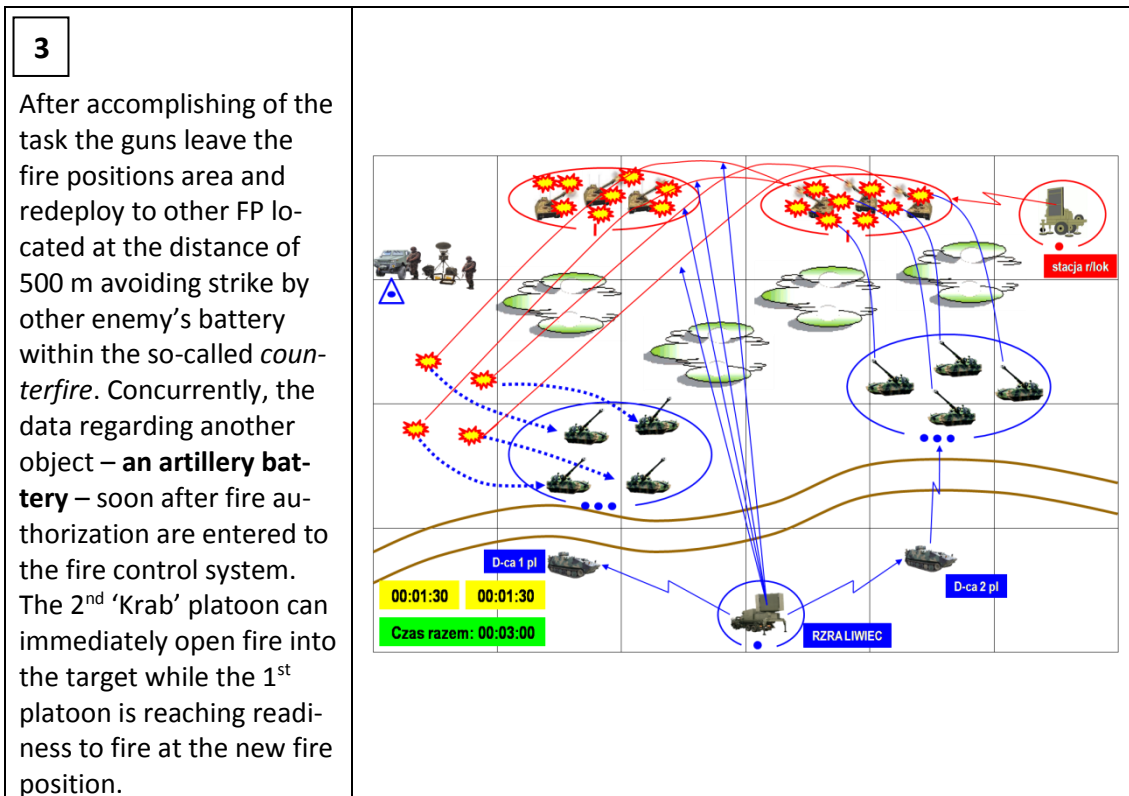
<sup>25</sup> ZOOPARK-2 is capable of determining 20 positions of fire assets within one minute (mean position determination error accounts up to 30 m regardless the indent distance) and tracking four targets in constant mode. Computed data are automatically forwarded to the own artillery command post. The maximum range of mortar positions' acquisition by ZOOPARK counts to 15 km, howitzers – 10 km, field missile launchers – 20 km and tactical surface-to surface missiles – 35 km. The time required for precise determining enemy's fire positions and data forwarding to a battery (battalion) conducting a fire task reaches up to 20 s.



sources, supported by experiences of the last armed conflict, indicate that depending on technical advancement the fire reaction time ranged from 5 to 12 min. The longest reaction time was always observed in the initial phase of operations whereas it successively decreased together with the development of the operation. Therefore, commencing considerations on the time of occupying a FP by a fire echelon it can be assumed that it will range from 3 to 5 min. after the first shell has been shot – the gun will have such amount of time before the first enemy’s shells will drop in FP area with- in *counterfire*. Thus, adopting the above-mentioned times and the sustained rate of fire of 155 mm hbs ‘Krab’ – 2 rounds per minute – for the considerations it can be concluded that 8-gun battery can shoot from 48 to 80 shells (battalion from 144 to 240) before the enemy’s fire response.

The variant of a fire echelon operation of 155 mm hbs ‘Krab’ during an active engagement with an enemy’s artillery which consists in conducting a fire task by an artillery battery operating by platoons using the shells of ‘BONUS’ type is presented below.





**Fig. 12.** Concept of striking an enemy's artillery by 155 mm hbs 'Krab' with the Bonus precision-guided ammunition – the variant

*Source: Own study.*

Due to the new capabilities of hbs 'Krab' unprecedented dispersion of guns in an artillery maneuver area (fire positions) can be obtained. Combining these capabilities with the short time of fire positions occupancy creates a significant number of difficulties for a potential enemy with regards to fighting 155 mm hbs 'Krab' which constitutes the essential feature increasing the sustainability of artillery units during combat operations.

## Conclusions

The methods of artillery subunits engagement into combat should evaluate according to ongoing transitions of the contemporary battlefield and changes occurring in the military technology. The transformations of the Polish artillery should take into account the following conclusions:

1. Autonomy of hbs 'Krab' allows for the application of innovative and unconventional methods of artillery subunits operation, increasing their capability of maintaining sustainability as well as enabling them to deviate from currently valid in the artillery term 'fire positions area – RSO' and replacing it by the term 'artillery maneuver area – AMA'.
2. 'Krab's significant range of fire predisposes it to the execution of tactical tasks in general support relation, providing freedom of maneuver and possibility to

achieve the intended operational aims by for the forces. However, the idea of assigning 'Krab' subunits to reinforce the artillery of general military brigades is not to be abandoned as it could significantly increase combat capabilities of direct support artillery.

3. Organizational structures of 155 mm hbs 'Krab' should provide the independence of a fire echelon with regards to operational support in each variant of battle formation configuration through the period of 3 to 5 days of sustained combat operations.
4. In order to entirely take advantage of the tactical-combat capabilities of 155 mm hbs 'Krab' it is necessary to develop and implement in the Polish Armed Forces a superior, digital and resistant to outside interferences command and fire control system of the artillery regiment, general military unit and tactical formation level which will allow for the automatic transfer of data about targets to the fire echelon in real time, without the need of generating and forwarding artillery commands, thus reducing the fire reaction time.
5. It is essential to reequip the fire echelon with the so-called emergency devices (portable universal artillery computers) and anti-jamming systems, among others, electromagnetic interference within the frame of alternate fire control tools which facilitate the guns and command vehicles crews with the reaction on external interferences preventing data transmission, calculation and determination of shooting settings, geodetic fixing and targeting.
6. In order to avoid *Friendly Fire*, mainly from the air force, hbs 'Krab' should be equipped with 'Friend or Foe' system.
7. Taking into consideration the capabilities of the new artillery ammunition, radical changes should be implemented regarding the regulations on ammunition allocation required for striking targets, instructional procedures on striking targets and basic artillery standards on its operations described in ISiKOAN and the shooting program of the Missile and Artillery Forces.
8. There is an urgent need to shift from the angular system operating in thousandth (60-00) to milliradians (64-00) and consequently rescaling observation devices (binoculars, sighting telescopes etc.), measurement devices (PAB-2A, PA-1 etc.) and fire control devices (PUO-9, PKO, SKART, UKART etc.).

According to the authors, the present paper due to the richness of the of the discussed topics and the innovativeness of numerous issues constitutes only introduction to undertaking the complex works aimed at updating the current views on the methods of engaging the artillery in the contemporary battlefield both in theory and in practice. Developing the concept of the artillery operation in the contemporary battlefield is one of the most significant and urgent tasks faced by the Polish artillerists in the second half of the 21<sup>st</sup> century.

### **Acknowledgement**

No acknowledgement and potential founding was reported by the authors.

### **Conflict of interests**

The author declared no conflict of interests.

### **Author contributions**

All authors contributed to the interpretation of results and writing of the paper. All authors read and approved the final manuscript.

### **Ethical statement**

The research complies with all national and international ethical requirements.

### **ORCID**

Norbert Swietochowski – The author declared that he has no ORCID ID's

Dariusz Rewak – The author declared that he has no ORCID ID's

### **References**

FM 3-09.70. (2000). *Tactics, Techniques and Procedures for M109A6 Howitzer (Paladin) Operations, Headquarters*. Department of The Army, August 2000.

Jarecki, C. (1998). *Wybrane problemy uzycia artylerii w armiach panstw NATO*. Warszawa: Akademia Obrony Narodowej.

Storsved, D. (2008). *PGK and the Impact of Affordable Precision on the Fires Mission*. 43rd Annual Guns & Missiles Symposium, 21-24 April 2008.

Szulc, T. (2011). *Radary artyleryjskie rodziny 1L220 ZOOPARK-2*. *Nowa Technika Wojskowa*, no. 8, pp. 32-36.

Szymanski, J. (1993). *Bonus*. *Nowa Technika Wojskowa*, no. 11, pp. 27-28.

### **Biographical notes**

**Norbert Swietochowski** – Lt. Col. PhD, Eng., graduated from the General J. Bem Military Academy of Missile and Artillery Forces in Toruń (1994), the Nicolaus Copernicus University in Torun (2002) and the National Defense University in Warsaw (2007) where he achieved the doctoral degree (2006). Since 2006 he worked as the lecturer and adjunct at the Tadeusz Kościuszko Military Academy of Land Forces. Currently he is the Head of Institute of Operations Support. He is the author of numerous publications related to artillery operations in armed conflicts and non-deadly weapon and its impact on national security.

**Dariusz Rewak** – Lt. Col. MSc. Eng., the graduate of the J. Bem Military Academy of Missile And Artillery Forces in Toruń (1995), the National Defense University of Warsaw (2003) and the Postgraduate Operational-Tactical Studies (2006). Between the years 1995-2014 he worked in the 1<sup>st</sup> Artillery Brigade and in 11<sup>th</sup> Artillery Regiment in Węgorzewo. In the years of 2014-2015 he held the position of the Chief of the Missile and Artillery Forces in the 21st Podhale Rifles Brigade. He has served in the Polish Military Contingent in Afghanistan twice, as the commander of the Artillery Training Team during the 10<sup>th</sup> rotation and as the deputy commander of the Military Advisory Team during the 13<sup>th</sup> rotation. Currently, he holds the position of the specialist in the Target-

ing Department in The Operational Command of Branches of Armed Forces. As the self-propelled artillery battalion commander in Węgorzewo in the years 2012-2013 he conducted the tasks associated with forming, preparing and training the personnel of the battalion fire module 'Regina' equipped with 155 mm hbs 'Krab'.

#### **How to cite this paper**

Swietochowski, N. and Rewak, D. (2018). 'KRAB' – new capabilities of the Polish Armed Forces. *Scientific Journal of the Military University of Land Forces*, vol. 50, no. 2(188), pp. 141-161, <http://dx.doi.org/10.5604/01.3001.0012.2501>



This work is licensed under the Creative Commons Attribution International License (CC BY).  
<http://creativecommons.org/licenses/by/4.0/>